



INSTRUCTION MANUAL

1400W ELECTRIC TILLER

Model No: THET1400 -- Product No: 193855002

ASSEMBLY REQUIRED
SAVE THESE INSTRUCTIONS
SPARES & SUPPORT: 01793 333212

Please read & understand this manual, paying attention to the safety instructions, before use.

The manufacturer reserves the right to change the product specification and livery according to continued product improvements.

All images used are for illustration purposes only.

CONTENTS

- SPECIFICATIONS
- IMPORTANT INFORMATION
- GENERAL SAFETY INSTRUCTIONS
- ELECTRICAL CONNECTION
- SET UP & PREPARATION FOR OPERATION
- MAINTENANCE & STORAGE
- TROUBLE SHOOTING
- PARTS LISTS & DIAGRAM
- WARRANTY
- EC DECLARATION OF CONFORMITY

If you require any assistance with regards to the contents or operation of your machine, please contact us:

Tel: 01793 333212

Email: customerservice@handydistribution.co.uk

Monday to Friday 8.00am to 5.30pm

(excl. Bank Holidays)

SPECIFICATIONS

The manufacturer reserves the right to change the product specification and livery according to continued product improvements.

Model	THET1400
Product Number	193855002
Motor Power	1400 watt
Motor Voltage	230V/50HZ
Idle Speed	330min ⁻¹
Working Width	430mm
Working Depth	200mm
Cable Length	10m
Max. Vibration	1.359m/s ² , k=1.5m/s ²
Noise Level L _{WA}	93 dB(A)

IMPORTANT INFORMATION



WARNING

Read this instruction manual carefully before operating this machine. Make sure that you are familiar with the controls and properly operate the machine. Following these instructions can reduce the risk of fire, electric shock and personal injury.

IF NOT USED PROPERLY THIS MACHINE CAN BE DANGEROUS!

This machine can cause serious injury to the operator and others, the warning and safety instructions must be followed to ensure reasonable safety and efficiency in using this product. The operator is responsible for following the warning and safety instructions in this manual and on the machine. Never use the product unless the blades or guards are correctly positioned.

DESIGNED FOR DOMESTIC USE ONLY.

The 1400 watt Electric Tiller is designed for use in private gardens, whose annual use does not generally exceed 50 hours & are primarily used for tilling shrubberies and allotments, but not in public facilities, parks or sports grounds and not for agricultural or forestry use.

Compliance with this manual supplied by the manufacturer is a prerequisite for the proper usage of the machine. The operating manual contains servicing & maintenance instructions as well as directions for use.

TRAINING

Read the instructions carefully: Be familiar with the controls and the proper use of the equipment.

Never allow children or people unfamiliar with these instructions to use the product. Local regulations can restrict the age of the operator.

Never operate while people, especially children, or pets are nearby.

Keep in mind that the operator or user is responsible for accidents or hazards involving the machine that occur to other people or their property.

ELECTRICAL REQUIREMENTS

Connect the main leads to a standard 230V+10% (50Hz+1Hz) electrical supply which has protection devices for under-voltage, over-voltage, over-current as well as a residual current device (RCD) with maximum residual current rated at 0.03A.

EXTENSIONS LEADS

Extension cables must be no longer than 50 metres in length. The cable section must be 1.5 mm² for cable lengths up to 25 metres & 2.5 mm² for cable lengths over 25 metres & 230V to allow sufficient current flow to the motor.

Improper use of extension cables may cause inefficient operation of the tiller, which can result in overheating and motor damage.

Only extension cords to H07RN-F specification intended for outdoor purpose may be used. Avoid use of free and inadequately insulated connections. Connections must be made with protected material suitable for outdoor use. Make sure that any extension cable connections are dry and safe. Ensure that the extension cable is carefully laid out avoiding liquids, sharp edges and places where vehicles might run over it. Avoid allowing the extension cable to come into contact with the tiller tines. Ensure your extension cable is fully extended to prevent overheating or the risk of fire.

WORKING CONDITIONS

This machine is a domestic use model. It is designed for operating under ambient temperatures between +5°C and 40°C and for installation at altitudes no more than 1000m above M.S.L. The surrounding humidity should be less than 50% at 40°C. It can be stored or transported under ambient temperatures between -25°C and 55°C.

GENERAL SAFETY INSTRUCTIONS

It is important that you read and understand the owner's manual and labels affixed to the machine. Learn its application and limitations as well as the specific potential hazards. Retain these instructions for future reference. The operator is responsible for following the warnings & instructions in this manual and on the product.

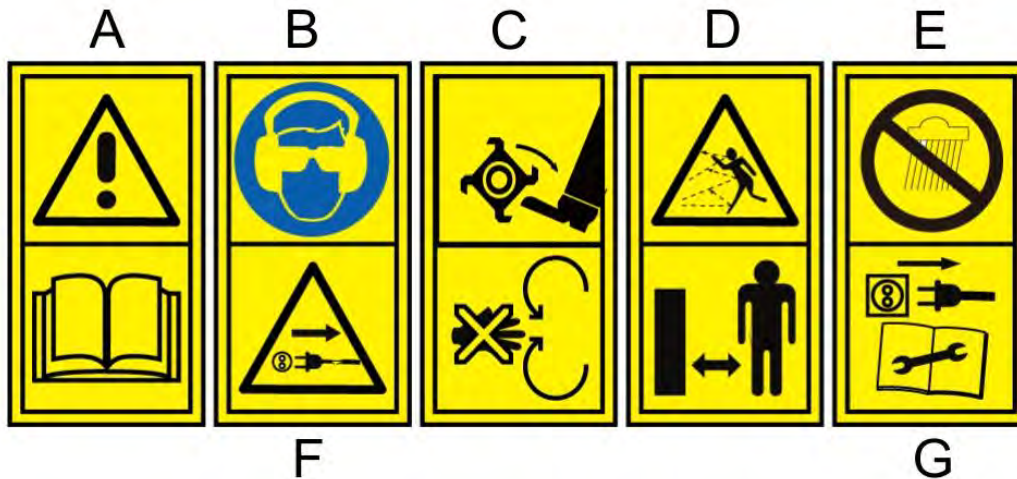

- A. CAUTION - Read & understand operator's manual before using the machine. Failure to follow instructions could result in death or serious injury.
- B. CAUTION - Whenever the machine is in use, safety glasses must be worn to safeguard against flying objects. We also recommend the use of ear protection.
- C. DANGER - Keep hands & feet away from the rotating tines.
- D. Keep all bystanders & animals at least 10 metres away from the machine during operation. If approached, stop the machine immediately.
- E. DO NOT use the machine in wet weather conditions.
- F. CAUTION - Stop the machine immediately if the power cable or plug becomes damaged.
- G. Disconnect from power supply when not in use, before moving, adjusting, changing parts, cleaning, or working on the machine. Never open the motor cover before disconnecting the electrical plug from the power supply.



Safety alert symbol. Used to alert you to potential personal injury hazards. Obey all safety messages that follow this symbol to avoid possible injury.



DANGER

Indicates an imminently hazardous situation which, if not avoided, will result in serious injury.



WARNING

Indicates a potentially hazardous situation which, if not avoided, could result in serious injury



CAUTION

Indicates a potentially hazardous situation which, if not avoided, may result in minor or moderate injury.

CAUTION

Used without the safety alert symbol indicates a potentially hazardous situation which, if not avoided, may result in property damage.

STAY ALERT

Do not operate the machine while under the influence of drugs, alcohol, or any medication that could affect your ability to use it properly. Do not use this machine when you are tired or distracted from the job at hand. Be aware of what you are doing at all times. Use common sense.

AVOID DANGEROUS CONDITIONS

Make sure there is adequate surrounding workspace. Cluttered areas invite injuries. Keep your work area clean with sufficient light. Keep the area around the machine clear of obstructions, grease, oil, rubbish and other debris which could cause persons to fall onto moving parts.

INSPECT YOUR MACHINE

Check all bolts, nuts, and screws for tightness before each use, especially those securing guards and drive mechanisms. Vibration during use, may cause these to loosen.

Form a habit of checking to see that all other tools/equipment are removed from the working area before turning it on.

Replace damaged, missing or failed parts before using it. Warning labels carry important information. Replace any missing or damaged warning labels.

DRESS PROPERLY

Do not wear loose clothing, gloves, scarfs, neckties or jewellery (rings, wrist watches), which can be caught in moving parts. Protective electrically non-conductive gloves and non-skid heavy duty footwear are highly recommended when working. Wear a face or dust mask if the operation is dusty. Always wear safety glasses/goggles and/or face shields. Everyday eyeglasses have only impact resistant lenses; they are not safety glasses/goggles. Wear protective hair covering to contain long hair, preventing it from getting caught in machinery.

AVOID ELECTRICAL SHOCK

Check that the electric circuit is adequately protected and that it corresponds with the power, voltage and frequency of the motor. Check that there is a ground connection, and a regulation differential switch further up the circuit. Ground the log splitter. Prevent body contact with grounded surfaces: pipes, radiators, ranges, and refrigerator enclosures. Never open the pushbutton box on the motor. Should this be necessary, contact a qualified electrician. Make sure your fingers do not touch the plug's metal prongs when plugging or unplugging the log splitter.

KEEP BYSTANDERS AND CHILDREN AWAY

Keep unauthorised persons a minimum distance of 10 metres away from the machine. If approached, stop the machine immediately. Do not allow children to handle or climb on the machine.

DO NOT OVERREACH

Keep proper footing and balance at all times when using the machine. Never stand on the machine. Serious injury could occur if the machine is tipped or if the moving parts are unintentionally contacted. Do not store anything above or near the machine, where anyone might stand on the machine to reach them.

AVOID INJURY FROM UNEXPECTED ACCIDENT

Keep hands & feet out of the way of all moving parts. Do not place any part of your body or any tool e.g. in the machine during operation.

DO NOT FORCE TOOL

Always work within the rated capacity. Do not use the machine for a purpose for which it was not intended.

NEVER LEAVE MACHINE RUNNING UNATTENDED

Do not leave the machine unattended until it has come to a complete stop.

MAINTAIN YOUR MACHINE WITH CARE



Clean the machine immediately after use. Keep the machine clean to ensure it operates to its full & safest performance. When maintaining this machine, only the manufacturer's original replacement parts should be used. The use of non-original manufacturer parts may invalidate your warranty.

PROTECT THE ENVIRONMENT

Take left over materials to an authorised collection point or follow the stipulations in the country where the machine is used. Do not discharge into drains, soil or water.

STORE IDLE EQUIPMENT

When not in use, the machine should be stored in a dry location. Keep the machine away from children and others not qualified to use it.

	Double insulated or class 2 electrical appliances are products that have been designed in a way so as not to require a safety connection to electrical earth (These products must NOT have a safety connection to Earth).
	Acoustic power level L _{WA} accordance with directive 2000/14/EC + 2005/88/EC (Please see machine & specification within this manual for actual reading)
	This symbol on the product or on its packaging indicates that this product may not be treated as household waste. Instead it shall be handed over to the applicable collection point for the recycling of electrical and electronic equipment. For more detailed information about recycling of this product, please contact your local council office, your household waste disposal service or shop where you purchased the product.

ELECTRICAL CONNECTION



Do not connect either core to the earth pin

The insulation on the grounded three metre electrical cord will only remain effective if the original insulating parts are used for repairs and the spaces between the original insulation are maintained. The use of a Residual Current Device ("RCD"), on 230V electrics is recommended. If using an extension cable, plug it directly into the RCD.

NOTE: A built-in thermal protector is fitted to shut off the motor to prevent it from overheating. The thermal protector restores automatically when the motor cools down. We recommend the machine is left to cool down for a period of more than 15 minutes, before an attempt is made to plug the machine back to the mains and switched on for operation. If the machine still does not operate, check RCD or extension cable for faults. If it still does not operate, contact your local approved service dealer.

SET UP & OPERATION

Remove the Tiller and contents from the carton. Be sure the carton is empty before discarding. If you require any assistance with regards to the contents of the Tiller, please contact us:

Tel: 01793 333212

Email: customerservice@handydistribution.co.uk

Monday to Friday 8.30am – 5.30pm (excl. Bank Holidays)



Description

1. Top Handle
2. Middle Handle
3. Cable Clip
4. Lower Guide Handle
5. Motor Housing
6. Fender
7. Tines
8. Wheel

CONNECTING THE HANDLES

- Attach the Middle Handle (2) onto the Lower Guide Handle (4) and secure it using two M6x45 screws and swing nuts supplied. **(Image 2)**
- Connect the Top Handle (1) to the Middle Handle (2) and secure it by two supplied screws and swing nuts. **(Image 1)**
- Tighten all screws and nuts completely.
- Using the two supplied cable clips (3) affix the electrical cable to the Handles. **(Image 3).**

OPERATION

Before operating the machine, please ensure you are fully aware of the below instructions, failure to do so, could invalidate your manufacturer's warranty. Completely unwind the electrical cable.

ADJUSTING THE SPUR

The position of the spur defines the working depth. **(Image 4)**

Image A - Use this position for transportation.

- Press the button to release the wheels. Pull the wheels down until the lock piece engages into the recess on the other side of the frame. Release the button and make sure the frame is locked firmly.

Image B - Use this position for working.

- Press the button to release the wheels. Pull the wheel up until the lock piece engages into the recess on the other side of the frame. Release the button and make sure the frame is locked firmly.

STARTING

Image 6

- Use your thumb to press the safety button (I) on the left side of the right handle and then press the trigger (II).
- The safety button is only used as a release, so that the motor can be started and does not have to be depressed, once the motor has been started.
- To turn the motor off, simply release the operation switch (II).

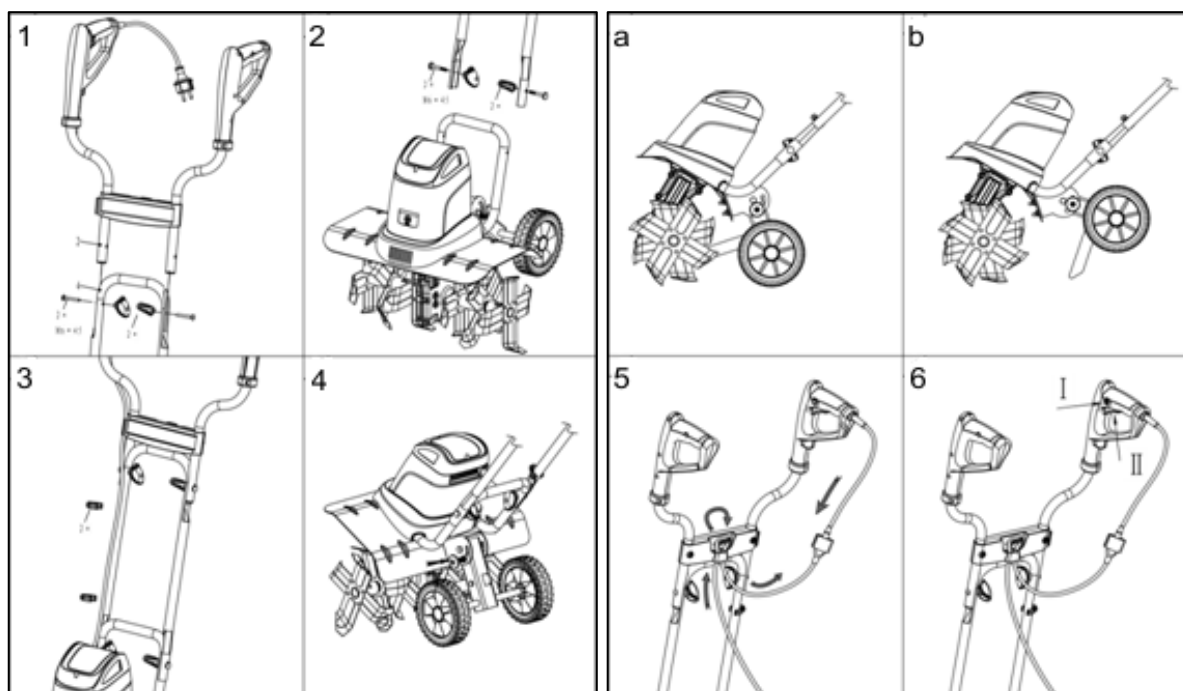

TIPS DURING OPERATION

Use the tiller for breaking sod, preparing seedbeds, and for cultivating gardens and flower beds. The tiller may also be used to dig small holes for planting saplings or potted plants.

- Move the appliance to the work area prior to starting the motor.
- Hold the appliance firmly, adjust the spur into the ground and raise the appliance and switch on the motor at no load.
- Press down on the handles until the appliance has dug to the depth required and then apply only sufficient pressure to maintain that depth.
- The tines will pull the tiller forward during operation.
- For deeper digging, best results can be achieved by several movements, especially when the ground is very hard or rough.
- By pulling tiller back towards yourself, the tines will dig deeper and more aggressively.
- For breaking sod or deep tilling, allow the tines to pull the tiller forward to the end of your arm's reach, firmly pull the tiller back towards you. By repeatedly allowing the tiller to move forward and then pulling back to you, the tiller will be most effective.
- If the tiller digs deep enough to stay in one spot, gently rock the tiller side to side to start the tiller moving forward again.
- For preparing a seed bed, we recommend you apply one of the tilling patterns shown in **Image 7**.
A – Make two passes over the area to be tilled, the second at a right angle to the first.
B – Make two passes over the area to be tilled, the second overlapping the first.

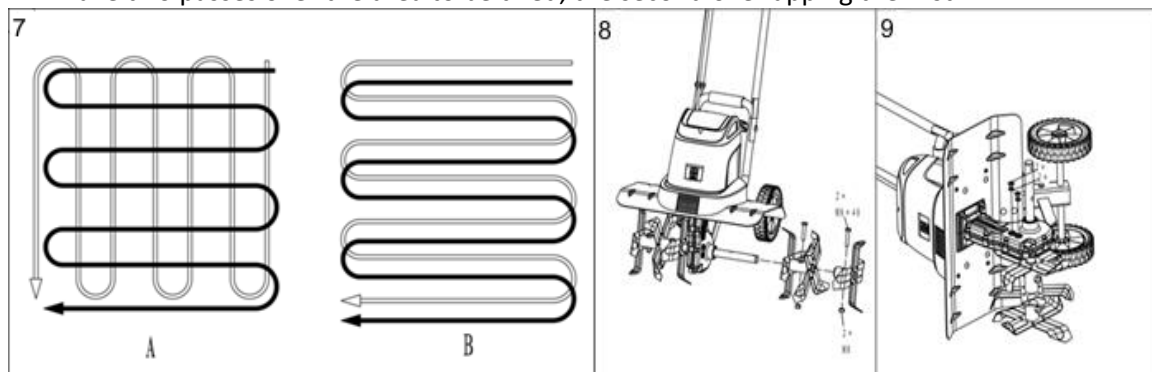

- To prevent tripping take particular care when moving backwards and when pulling the tiller.
- Always let the tines rotate at top speed; do not work in such a way as to overload the appliance.
- Never pass the tiller over the extension cord; make sure the cord is always in a safe position behind your back.
- Tilling only when it is suitable. Frozen or waterlogged ground, if cultivated, can cause poor soil moisture movement.
- When working on inclines, always stand diagonally to the incline in a sturdy, safe stance. Do not work on extremely steep slopes.

GENERAL USE

- Always operate the machine on a level surface, ensuring the machine to stable and free from obstructions
- If using an extension cable, ensure it is suitable for outdoor usage, 14AWG or above and no more than 10 metres in length.

MAINTENANCE & STORAGE



WARNING

Improper maintenance & storage of the machine may void your warranty. Keep the machine clean for better and safer performance.

MAINTENANCE

- Before each use, check all nuts & bolts to be sure they are sufficiently tightened.
- Keep all moving parts lightly greased, using Multi-purpose grease.
- Ensure the breather openings on the motor casing are open and clean from debris. If they are blocked, the motor could overheat and shut the machine down.
- We recommend only manufacturer original parts are used when maintaining this machine. Failure to do so could invalidate your manufacturer's warranty.



CAUTION

Any maintenance and repairs carried out, to any electronic component must be undertaken by a qualified technician.

CLEANING

- Keep your machine clean.
- Before cleaning, ensure it is unplugged from the mains.
- Thoroughly clean the machine at the end of each day's operation.
- Clean the underside of the housing around the tines, protective shield and fender with a scrubbing brush, and brush or soft cloth dampened with a mild soap and water mixture. Never splash with water!
- To remove soil and debris from the tines and transmission, use a stiff brush or a dampened cloth.
- Clean the air vents, and remove any remaining grass or dirt.
- Once cleaned, wipe the tine and shaft dry and apply a light coat of oil.



CAUTION

Clean the tool after each use. Failure to carry out proper cleaning can result in damage to the appliance or cause it to malfunction.



WARNING

Injury may occur when working on the tines. Wear protective gloves.

CAUTION

Wipe off any external material on the motor cover. Do not use petrol, turpentine, lacquer or paint thinner, dry cleaning fluids or similar products. The use of chemical products or solvents may affect the properties of the cover which has been produced using high density polyethylene (PET).

WORN TINES



CAUTION

Disconnect the mains and wear protective gloves when you attempt any kind of maintenance to the tines.

- Worn tines lead to poor performance and may overload the motor.
- Check the tines' condition before each use. Sharpen or replace the tines with new one when necessary. It is recommended to have this done by an approved Handy dealer.

To remove and install the tines from/to the tine bracket. (Image 8)

- Loosen the screws on one side while holding the lock nuts from the other side.
- Pull the set of tines from the shaft.
- The sets of tines are re-installed in reverse order.

TRANSMISSION

The drain plug is located on the left side of gearbox housing. **(Image 9)**

- Check, replace or top up the gearbox lubricant after every 30 hours of operation or at least once a year.
- Put the tiller on its left side and clean the transmission housing before removing the drain plug to prevent dirt and debris from getting into the gearbox.
- Using a 5mm Allen key, unscrew both plugs. If necessary, disassemble tines.

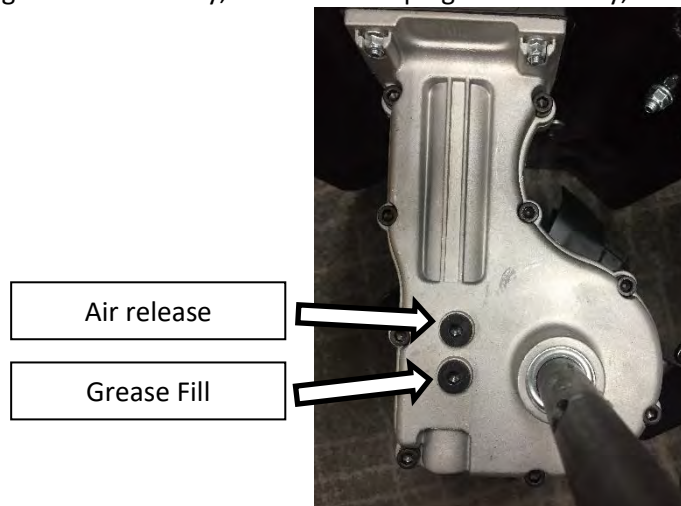

- We recommend MOBILUX EP 023 grease and filled using a grease gun. 90g will fill an empty gearbox until it begins to seep out around the edge of the hole of the nozzle.
- Check the O-ring on both plugs for sign of wear and damage, replace if necessary.
- Reinstall the fill & air release plugs, using 5mm Allen key until secure.

STORAGE

- For years of trouble free service, make sure the Tiller is clean and dry before storing.
- Wipe all metal surfaces with an oil-impregnated cloth to protect them from corrosion (non-resinous oil), or spray a fine coat of oil.
- Before storing, clean the Tiller thoroughly as indicated above.
- Store indoors or in a protected area during severe weather and winter months. Fold the Top Handle over and store in a suitable place

TROUBLE SHOOTING

PROBLEM	POSSIBLE CAUSES	RESOLUTION
Motor cannot be started	<ol style="list-style-type: none"> 1. No power 2. Cable damaged 3. Overheat protection activated 	<ol style="list-style-type: none"> 1. Check mains supply 2. Check cable, replace or have repair by approved electrician 3. Let the motor cool down for over 15 minutes, before your resume work. <ol style="list-style-type: none"> a. Working depth too deep. Adjust tilling depth. Run over same ground multiple times, to reach required depth. b. Tines are blocked, remove debris c. Soil is too hard, adapt working depth accordingly. Run over same ground multiple times, to reach required depth.
Unusual Noise	<ol style="list-style-type: none"> 1. Tines are blocked 2. Gearbox oil leak 3. Loose nuts, bolts, or other fastening 	<ol style="list-style-type: none"> 1. Switch off the machine, wait for remove the plug from the mains. 2. Contact your local approved dealer 3. Tighten all, if noise continues contact your local approved dealer
Excessive Vibration	<ol style="list-style-type: none"> 1. Tines are damaged or worn 2. Working depth too deep 	<ol style="list-style-type: none"> 1. Replace the tines or have machine inspected by approved dealer. 2. Adjust tilling depth. Run over same ground multiple times, to reach required depth.
Poor Tilling Results	<ol style="list-style-type: none"> 1. Working depth too low 2. Tines are damaged or worn 	<ol style="list-style-type: none"> 1. Adjust tilling depth. 2. Replace the tines or have machine inspected by approved dealer.

PARTS DIAGRAM – THET1400 (193855002)

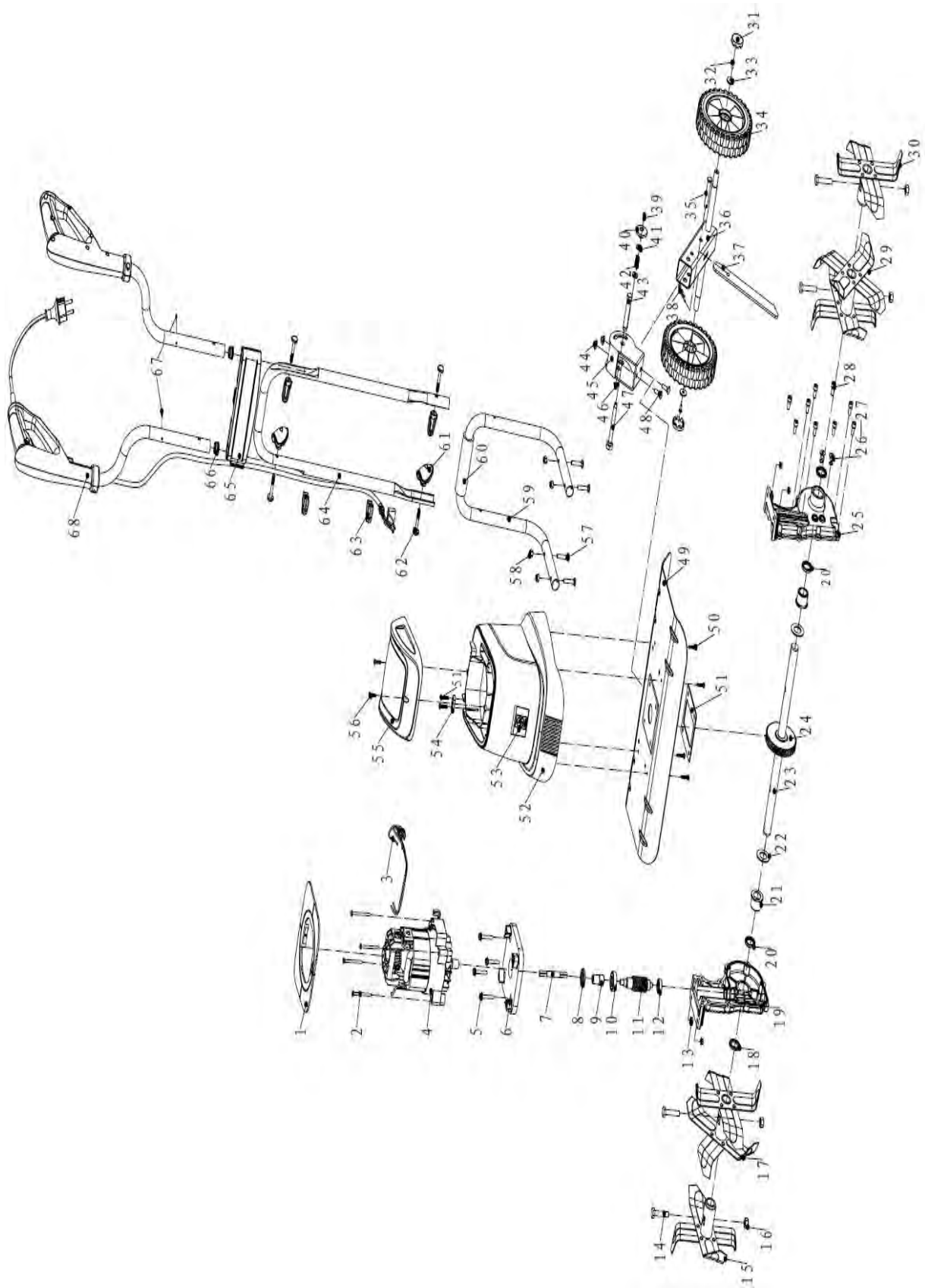

PARTS LIST – THET1400 (193855002)

Item No	Part No.	Description	Qty
1	TH217-182257003300	Shield	1
2	TH217-120421164050	Screw ST4x50	4
3	TH217-132257263000	Coil	1
4	TH217-0022572600000	Motor	1
5	TH217-120441120525	Screw M5x25	4
6	TH217-182241221000	Motor Base	1
7	TH217-202241004030	Flexi-Shaft	1
8	TH165-5	Rubber Seal Φ14*Φ28*4.5	1
9	TH217-222231008000	Connector	1
10	TH165-3	Bearing6200	1
11	TH217-202241301000	Worm Shaft	1
12	TH165-1	Bearing 608	1
13	TH217-120350020500	Nut M5	4
14	TH165-24	Screw M8x40	4
15	TH217-202252560010	Blade Set Right C	1
16	TH217-120330020800	Nut M8	4
17	TH165-25	Blade Set Right A	1
18	TH217-202211020020	Ring	2
19	TH217-212241230080	Transmission Case Right	1
20	TH165-29	Rubber Seal Φ19*Φ27*4.5	2
21	TH165-30	Oil Bearing	2
22	TH217-202231344020	Washer Φ19.2*Φ34*1.5	2
23	TH217-202257201010	Tine Shaft	1
24	TH217-202241302000	Worm Wheel	1
25	TH217-212241240080	Transmission Case Left	1
26	TH165-36	O-Ring	2
27	TH165-37	Transmission Screw	2
28	TH165-39	Screw M6x16	9
29	TH165-38	Blade Set Left B	1
30	TH217-202252500010	Blade Set Left D	1
31	TH217-182231267200	Wheel Cover	2
32	TH217-120411120512	Screw M5x12	2
33	TH217-120210020815	Washer φ8×φ15×1.6	2
34	TH217-182251380200	Wheel	2

Item No	Part No.	Description	Qty
35	TH217-202811305010	Cotter pin	1
36	TH217-202811266070	Wheel Axle	1
37	TH217-202811302070	Spur	1
38	TH217-202811305010	Split Pin	1
39	TH217-120411120410	Screw M4x10	1
40	TH217-182811267200	Adjusting Knob	1
41	TH217-120210020815	Washer φ8×φ15×1.6	2
42	TH217-232811265020	Adjusting Spring	1
43	TH217-202811263020	Support Pin	1
44	TH217-120350020600	Nut M6	2
45	TH217-232811262070	Holder	1
46	TH217-120250001000	Ring	1
47	TH217-202811264020	Adjusting Screw	1
48	TH217-120418120616	Screw M6x16	2
49	TH217-202257221070	Protective Shield	1
50	TH165-12	Screw ST3.9x19	6
51	TH217-192241245000	Rubber Seal	1
52	TH217-182257001200GM	Motor Housing	1
53	TH217-182257004200	Label	1
54	TH165-21	Cable Holder	1
55	TH217-182257002200	Upper Housing	1
56	TH217-120421163916	Screw ST3.9x16	2
57	TH217-120418120630	Screw M6x30	4
58	TH217-120330020600	Nut M6	4
59	TH217-202257222070	Lower Guide Handle	1
60	TH217-242216601000	Sponge Sleeve	1
61	TH165-45	Handle Fixing Knob (Green)	4
62	TH165-13	Screw M6x45	4
63	TH165-14	Cable Clip (Green)	2
64	TH217-202225002100	Middle Handle	1
65	TH217-182225201200	Handle Brace	1
66	TH217-182411422210	Gearbox Drain Plug	2
67	TH217-120421264213	Screw ST4.2x30	2
68	TH217-0022572400000GM	Top Handle	1

GJ HANDY & CO LTD USER WARRANTY POLICY

Users Statement of Warranty

Each new machine is warranted against defective material or assembly of material under normal usage. The warranty applies to the original purchaser and covers faulty parts and the labour involved in replacing and repairing those parts, which are of original manufacture.

Period of Warranty

Webb (excludes Electric Handheld)

Webb Pro

Sanli Engine

- a) 2 years from the original date of sale to the first domestic user.
- b) 90 days from the original date of sale to the professional/commercial user.
- c) 90 days from the original date of sale when used for hire.
- d) A reduced warranty period of 90 days applies to those items which are subject to normal wear and tear (e.g. but not limited to wheels, tyres, cutter bars, cylinders, cutting blades, blade boss, belts, cables, nylon line & spool, collection bags, spark plugs).
- e) Engines are supplied with a separate warranty to the machine. The engine manufacturers warranty statement which will be supplied within the engine instruction manual. All enquiries and warranty repairs should be discussed with the engine manufacturer or approved warranty repair dealer.
- f) 90 days from the original date of purchase for Replacement Spare Parts (unless normal wear & tear component, which are covered for 30 days).
- g) All machines' must be serviced within the first 12 months from the original date of purchase to comply with the warranty, failure to do so will invalidate the 2nd year of the warranty.

All warranty repairs must be undertaken by an authorised service dealer. These dealers have been accredited by GJ Handy & Co Ltd and agree to only use genuine parts and follow our repair procedures.

Webb Electric Handheld

Handy

Mowerland

Q-Garden

- a) 1 year from the original date of sale to the first domestic user.
- b) 90 days from the original date of sale to the professional/commercial user.
- c) 90 days from the original date of sale when used for hire.
- d) A reduced warranty period of 90 days applies to those items which are subject to normal wear and tear (e.g. but not limited to wheels, tyres, cutter bars, cylinders, cutting blades, blade boss, belts, cables, nylon line & spool, collection bags, spark plugs).
- e) Engines are supplied with a separate warranty to the machine. The engine manufacturers warranty statement which will be supplied within the engine instruction manual. All enquiries and warranty repairs should be discussed with the engine manufacturer or approved warranty repair dealer.
- f) 90 days from the original date of purchase for Replacement Spare Parts (unless normal wear & tear component, which are covered for 30 days).

All warranty repairs must be undertaken by an authorised service dealer. These dealers have been accredited by GJ Handy & Co Ltd and agree to only use genuine parts and follow our repair procedures.

GJ HANDY & CO LTD USER WARRANTY POLICY

Not covered by this warranty

- a) The warranty policy does not cover any depreciation or damages caused by ordinary wear, rusting or corrosion, lack of correct maintenance or operation, misuse, abuse, lack of transportation or accident.
- b) The warranty policy does not cover any costs necessary for the standard periodic maintenance services instructed by the operator's manual, or service parts replacement which would include oil, filters, tyres, belts, brake linings, fuses, blades, seals and other service parts unless it can be proven that the item has evidence of faulty manufacture.
- c) The warranty policy will not cover failure or damage caused as a result of parts or accessories being modified without the written approval of GJ Handy & Co Ltd.
- d) The warranty policy will not cover the unit if non-genuine parts have been fitted and as a result damage has occurred to the unit.
- e) The warranty policy is non-transferable and is only applicable to the original purchaser.

Disclaimer

- a) This warranty is only a remedy for defect of products. GJ Handy & Co Ltd will never warranty in terms of the merchantability or the fitness for a particular purpose.
- b) No person is authorised to make any warranties, representations or promises, expressed or implied, on behalf of GJ Handy & Co Ltd, or to modify the terms conditions or limitation of this warranty policy in any way.
- c) Neither GJ Handy & Co Ltd nor any company affiliated with GJ Handy & Co Ltd shall be liable in any event or manner whatsoever for incidental or consequential damages or injuries, including, but not limited to, loss of crops, loss of profit, out of pocket expenses or profits, rental of substitute equipment or other commercial losses.

General

- a) Most warrantable failures show up within the first few weeks of use. These failures are usually straightforward and warranty assessment is relatively easy.
- b) Failures relating to cutter decks and belts need careful investigation, as the cause may not always be straightforward. Look for damage to blades and pulleys especially when the cutter belt or blade boss have snapped or cracked as this could be due to impact damage.
- c) Customers should always refer to the operator/instruction manual when any disputed problem arises, you will find most areas covered within the manual.



EC DECLARATION OF CONFORMITY

We Handy Distribution Ltd - SN3 5HY (Importer) declare that the product:

Designation: 1400w Electric Tiller

Model(s): THET1400

Product No. 193855002

Motor Power: 1400 watt

Motor Voltage: 230V/50HZ

Idle Speed: 330min-1

Type/Serial No. As per rating label on machine

Complies with the following directives:

2006/42/EC - Machinery Directive

2004/108/EC – Electro Magnetic Directive

2000/14/EC – Noise Directive

The conformity assessment procedure followed was in accordance with

EN 55014-1:20016+A1+A2, EN55014-2:1997+A1+A2, EN 61000-3-2:2006+A1+A2,
EN 61000-3-3:2013, EN ISO 3744:2010, EN 709:1997+A4, EN 60335-1:2012, EN 62233:2008

Notified Body:

TUV Rheinland LGA Products GmbH

Addresses:

Tillystrasse 2, 90431 Nurnberg, GERMANY

Additional Information

Guaranteed Sound Power: LWA = 93dB(A)

Max. Measured Vibration: 1.359m/s²

Authorised signatory & technical file holder

Date:

22/11/2017

Signature:

A handwritten signature in black ink, appearing to read 'S Belcher', written over a horizontal line.

Name & Position

Mr. Simon Belcher - Managing Director

Company:

Handy Distribution Ltd

Address:

Murdock Rd, Dorcan, Swindon, Wiltshire, SN3 5HY.

For spares or support of your handy product,
please contact us:

Tel: 01793 333212

Email: customerservice@handydistribution.co.uk

(Monday to Friday 8.00am to 5.30pm
excl. Bank Holidays)

To see our range of garden machinery & equipment visit:

www.thehandy.co.uk

Making gardening easier & affordable since 1938

Distributed by Handy Distribution, Murdock Road, Dorcan, Swindon, SN3 5HY