



# INSTRUCTION MANUAL

## 3.6V LITHIUM-ION CORDLESS HAND SHEAR

MODEL NO: THGSS -- PRODUCT NO: 1938195001

**EN - ORIGINAL INSTRUCTIONS**

**SAVE THESE INSTRUCTIONS**

**SPARES & SUPPORT: 01793 333212**

### **FOR YOUR SAFETY**

Please read & understand this manual, paying attention to the safety instructions, before use.

Incorrect use of the product could put the operator or machine in danger.

Whilst every effort has been made to ensure the accuracy of information contained in this manual, our policy of continuous improvement determines the right to make modifications without prior warning.

Images used are for illustration purposes only

### *Copyright Notice*

Copyright © Handy Distribution

Permission is granted to reproduce this publication for personal & educational use only.

Commercial copying, redistribution, hiring or lending is prohibited.

No part of this publication may be stored in a retrieval system or transmitted in any other form or means without written permission from Handy Distribution.

In all cases this copyright notice must remain intact.

## **CONTENTS**

**SPECIFICATIONS**

**IMPORTANT INFORMATION**

**GENERAL SAFETY INSTRUCTIONS**

**SET UP & PREPARATION FOR OPERATION**

**ASSEMBLY**

**OPERATION**

**MAINTENANCE & CLEANING**

**SERVICE HINTS**

**EC DECLARATION OF CONFORMITY**

**PARTS DIAGRAM & LIST**

**WARRANTY**

**NOTES**

**If you require any assistance with regards to the contents or operation of  
your machine, please contact us:**

**TEL: 01793 333212**

**EMAIL: [customerservice@handydistribution.co.uk](mailto:customerservice@handydistribution.co.uk)  
(MON – FRI 8.00AM TO 5.30PM EXCL. BANK HOLIDAYS)**

## SPECIFICATIONS

The manufacturer reserves the right to change the product specification and livery according to continued product improvements.

<b>Model Number</b>	<b>THGSS</b>
<b>Product Number</b>	<b>1938195001</b>
<b>Battery Type</b>	<b>Lithium-ion</b>
<b>Battery Voltage</b>	3.6V - 1.5Ah
<b>No Load Speed</b>	1180rpm
<b>Battery Charge Time</b>	Up to 3 hours
<b>Battery Run Time</b>	Hedge Shear - Up to 45 mins Grass Shear - Up to 25 mins
<b>Operation Cutting Output</b>	0.6Ah
<b>Weight</b>	N.W 0.7kg
<b>Noise Emission Value</b>	L <sub>WA</sub> 80 dB(A)
<b>Vibration</b>	< 2.5 m/s <sup>2</sup> - Uncertainty K: 1,5m/s <sup>2</sup>

## IMPORTANT INFORMATION

### IF NOT USED PROPERLY THIS MACHINE CAN BE DANGEROUS!

This machine can cause serious injury to the operator and others, the warning and safety instructions must be followed to ensure reasonable safety and efficiency in using this product. The operator is responsible for following the warning and safety instructions in this manual and on the machine. Never use the product unless the fixing screws or guards are correctly positioned.

### DESIGNED FOR DOMESTIC USE ONLY.

The Grass/Hedge Shear is designed for use in private gardens, whose annual use does not generally exceed 50 hours and that are primarily used for tending HEDGES, BUSHES & LAWNS, but not in public facilities, parks or sports grounds and not for agricultural or forestry use.

Compliance with this manual supplied by the manufacturer is a prerequisite for the proper usage of the machine. The operating manual contains servicing and maintenance instructions as well as directions for use.

### TRAINING

Read the instructions carefully: Be familiar with the controls and the proper use of the equipment.

















Never allow children or people unfamiliar with these instructions to use the product. Local regulations can restrict the age of the operator.

Never operate while people, especially children, or pets are nearby.

Keep in mind that the operator or user is responsible for accidents or hazards involving the machine that occur to other people or their property.

## GENERAL SAFETY INSTRUCTIONS

It is important that you read and understand the owner's manual and labels affixed to the machine. Learn its application and limitations as well as the specific potential hazards. Retain these instructions for future reference. The operator is responsible for following the warnings & instructions in this manual and on the product.

	Read & understand operator's manual before using the machine. Failure to follow instructions could result in death or serious injury.		<b>WARNING!</b> Cutting blades continue to run after the motor is switched off
	Wear protective gloves to protect your hands		Keep bystanders away
	Always wear eye protection and stout shoes while operating the machine		For the charger: Remove plug from the mains immediately if the cable is damaged or cut.
	Keep guards in place and in working order. Replace damaged, missing or failed parts before using it.		<b>DANGER</b> Keep hands away from the blade.
	Do not use in the rain or damp conditions.		IPX1
	Safety alert symbol. Used to alert you to potential personal injury hazards. Obey all safety messages that follow this symbol to avoid possible injury.		Indicates an imminently hazardous situation which, if not avoided, will result in serious injury.
	Indicates a potentially hazardous situation which, if not avoided, could result in serious injury		Indicates a potentially hazardous situation which, if not avoided, may result in minor or moderate injury.
	Used without the safety alert symbol indicates a potentially hazardous situation which, if not avoided, may result in property damage.		EU Declaration of Conformity
	Only for EC countries: According to the European law 2012/19/EU, electrical and electronic equipment that are no longer usable, and according to the European law 2006/66/EC, defective or used battery packs/batteries, must be collected separately and disposed of in an environmentally correct manner.	Integrated batteries may only be removed for disposal. Opening the housing shell can damage or destroy the garden product. When removing the battery from the garden product, actuate the ON/OFF switch until the battery is completely discharged. Unscrew the screw in the casing and take off the casing shell. Disconnect the connections on the battery and remove the battery.	

**WARNING!**

**Read all safety warnings and all instructions!**

**Failure to follow the warnings and instructions may result in electric shock, fire and / or serious injury.**

**Save all warnings and instructions for future reference. The term “power tool” in the warnings refers to your mains operated (corded) power tool or battery operated (cordless) power tool.**

**WORK AREA SAFETY**

- a) Keep work area clean and well lit. Cluttered or dark areas invite accidents.
- b) Do not operate power tools in explosive atmospheres, such as in the presence of flammable liquids, gases or dust. Power tools create sparks which may ignite the dust or fumes.
- c) Keep children and bystanders away while operating a power tool. Distractions can cause you to lose control.

**ELECTRICAL SAFETY**

- a) Charger plugs must match the outlet. Never modify the plug in anyway. Do not use any adaptor plugs with earthed (grounded) power tools. Unmodified plugs and matching outlets will reduce risk of electric shock.
- b) Avoid body contact with earthed or grounded surfaces, such as pipes, radiators, ranges and refrigerators. There is an increased risk of electric shock if your body is earthed or grounded.
- c) Do not expose power tools or chargers to rain or wet conditions. Water entering a power tool will increase the risk of electric shock.
- d) Do not abuse the charger cord. Never use the charger cord for carrying, pulling or unplugging the power tool. Keep cord away from heat, oil, sharp edges or moving parts. Damaged or entangled cords increase the risk of electric shock.

**PERSONAL SAFETY**

- a) Stay alert, watch what you are doing and use common sense when operating a power tool. Do not use a power tool while you are tired or under the influence of drugs, alcohol or medication. A moment of inattention while operating power tools may result in serious personal injury.
- b) Use personal protective equipment. Always wear eye protection. Protective equipment such as dust mask, nonskid stout shoes, hard hat, or hearing protection used for appropriate conditions will reduce personal injuries.
- c) Prevent unintentional starting. Ensure the switch is in the off-position, when picking up or carrying the tool. Carrying power tools with your finger on the switch or energizing power tools that have the switch on, invite accidents.
- d) Remove any adjusting key or wrench before turning the power tool on. A wrench or a key left attached to a rotating part of the power tools may result in personal injury.
- e) Do not overreach. Always keep proper footing and balance. This enables better control of the power tool in unexpected situations.
- f) Dress properly. Do not wear loose clothing or jewellery. Keep your hair, clothing and gloves away from moving parts. Loose clothes, jewellery or long hair can be caught in moving parts.

**POWER TOOL USE AND CARE**

- a) Do not force the power tool. Use the correct power tool for your application. The correct power tool will do the job better and safer at the rate for which it was designed.
- b) Do not use the power tool if the switch does not turn it on and off. Any power tool that cannot be controlled with the switch is dangerous and must be repaired.
- c) Disconnect the plug from the power source and from the power tool before making any adjustments, changing accessories, or storing power tools. Such preventive safety measures reduce the risk of starting the power tool accidentally.
- d) Store idle power tools out of the reach of children and do not allow persons unfamiliar with the power tool or these instructions to operate the power tool. Power tools are dangerous in the hands of untrained users.
- e) Maintain power tools. Check for misalignment or binding of moving parts, breakage of parts and any other condition that may affect the power tool's operation. If damaged, have the power tool repaired before use. Many accidents are caused by poorly maintained power tools.
- f) Keep cutting tools sharp and clean.  
Properly maintained cutting tools with sharp cutting edges are less likely to bind and are easier to control.
- g) Use the power tool, accessories and tool bits etc. in accordance with these instructions, considering the working conditions and the work to be performed. Use of the power tool for operations different from those intended could result in a hazardous situation.

## **BATTERY TOOL USE AND CARE**

- a) Recharge only with the charger specified by the manufacturer. A charger that is suitable for one type of battery may create a risk of fire when used with another battery.
- b) Use power tools only with specifically designated batteries. Use of any other battery may create a risk of injury and fire.
- c) When battery pack is not in use, keep it away from other metal objects, like paper clips, coins, keys, nails, screws or other small metal objects, that can make a connection from one terminal to another. Shorting the battery terminals together may cause burns or a fire.
- d) Under abusive conditions, liquid may be ejected from the battery; avoid contact. If contact accidentally occurs, flush with water. If liquid contacts eyes, additionally seek medical help. Liquid ejected from the battery may cause irritation or burns.

## **SERVICE**

Have your power tool serviced by a qualified repair person using only identical replacement parts. This will ensure that the safety of the power tool is maintained.

Grass Shear trimmer safety warnings:

- Keep all parts of the body away from the cutter blade. Do not remove cut material or hold material to be cut when blades are moving. Make sure the switch is off when clearing jammed material. A moment of inattention while operating the grass shear may result in serious personal injury.
- Carry the grass shear by the handle with the cutter blade stopped. When transporting or storing, ensure the blade cover is fitted.

Proper handling of the grass shear will reduce possible personal injury from the cutter blades.

- Hold the power tool by insulated gripping surfaces only, because the cutter blade may contact hidden wiring or its own cord. Cutter blades contacting a “live” wire may make exposed metal parts of the power tool “live” and could give the operator an electric shock.

## **SAFE OPERATION PRACTICES FOR GRASS SHEARS**

### *TRAINING*

- a) Read the instructions carefully. Be familiar with the controls and the correct use of the machine.
- b) Never allow children or people unfamiliar with these instructions to use the machine. Local regulations can restrict the age of the operator.
- c) Keep in mind that the operator or user is responsible for accidents or hazards occurring to other people or their property.

### *PREPARATION*

- a) Before use, check the supply cord for signs of damage or aging. If the cord becomes damaged during use, disconnect the cord from the supply immediately. **DO NOT TOUCH THE CORD BEFORE DISCONNECTING THE SUPPLY.** Do not use the charger if the cord is damaged or worn.
- b) Before use, always visually inspect the machine for damaged, missing or misplaced guards or shields.
- c) Never operate the machine while people, especially children, or pets are nearby.

### *OPERATION*

- a) Keep supply and extension cords away from cutting means.
- b) Wear eye protection and stout shoes at all times while operating the machine.
- c) Avoid using the machine in bad weather conditions, especially when there is a risk of lightning.
- d) Use the machine only in daylight or good artificial light.
- e) Never operate the machine with damaged guards or shields or without guards or shields in place.
- f) Switch on the motor only when hands and feet are away from the cutting means.
- g) Take care against injury to feet and hands from the cutting means.
- h) Always ensure that the ventilation openings are kept clear of debris.

### *MAINTENANCE AND STORAGE*

- a) Disconnect the machine from the power supply (i. e. remove the plug from the mains remove the disabling device or removable battery) before carrying out maintenance or cleaning work.
- b) Use only the manufacturer’s recommended replacement parts and accessories.
- c) Inspect and maintain the machine regularly. Have the machine repaired only by an authorised repairer.
- d) When not in use, store the machine out of the reach of children.

## ADDITIONAL SAFETY WARNINGS

### BATTERY SAFETY



#### **DANGER FIRE RISK**

**The battery product to be charged must be placed on a non-flammable, heat resistant and non-conductive surface while charging. Keep corrosive, flammable and easily combustible objects clear of the battery charger and the battery product. Do not cover the battery charger and the battery product while charging.**

Disconnect the battery charger immediately in the event of smoke formation or fire.

Only use the original charger to charge the battery. The use of other battery chargers may damage the batteries irreparably and even cause a fire.

Do not charge any third-party batteries. There is a risk of fire and explosion!

If you notice fire: Extinguish the flames with oxygen reducing materials.



#### **DANGER RISK OF EXPLOSION**

**Protect battery products from heat and fire. Do not leave on radiators or expose to strong sunshine for long periods. Do not operate in explosive atmospheres, such as in the presence of flammable liquids, gases, or dust. Battery products may create sparks which could ignite the dust or fumes.**

Only charge and use the battery product in ambient temperatures of between 0°C and 40°C.

Allow battery to cool down after long periods of use.

Check the charging cable regularly for signs of damage or ageing (brittleness). Only use it in perfect condition.

Do not stow or transport the battery product above 45°C or in direct sunlight. Ideally, the battery product should be stored below 25°C so that self-discharge is low.

Do not expose the battery product to rain or wet conditions. Water entering a battery product will increase the risk of electric shock.

If usage of the battery is not planned for a certain time (winter period) recharge the battery to avoid a deep discharge.

Do not store the battery product in places where static electricity is present.

### **ELECTRICAL SAFETY**



#### **DANGER CARDIAC ARREST**

**This product makes an electromagnetic field while it operates. This field may under some conditions interfere with active or passive medical implants.**

**To decrease the risk of conditions that can possibly injure or kill, we recommend persons with medical implants speak with their physician and the medical implant manufacturer before you operate the product.**

Thoroughly inspect the area where the product is to be used and remove all wires and other foreign objects.

Before using the product and after any impact, check for signs of wear or damage and repair as necessary.

If the product can no longer be switched off in the event of a defect, place the product on a solid surface and monitor it until the battery is empty.

Never attempt to use an incomplete product or one with an unauthorised modification.

Stop the product if the product starts to vibrate abnormally. Check immediately. Excessive vibration can cause injury.

Do not use the product nearby water. Do not operate next to swimming pools or garden ponds.



## PERSONAL SAFETY



### **DANGER**

#### **RISK OF SUFFOCATION**

**Small parts can be easily swallowed. There is also a risk that the polybag can suffocate toddlers. Keep toddlers away when you assemble the product. Dispose of the polybag responsibly.**

Know how to stop the product quickly in an emergency. Only work in the daylight or when visibility is good.

Check your product before each use. Always visually inspect your grass shear before each use. Check that the ventilation slots are not obstructed in any way.

Check the blade before usage. Keep the blade well maintained. If the product gets hot while in operation, let it cool down before storage.

Do not overload the product.

### **WARNING**

**When wearing hearing protection and due to the noise produced by the product, the operator may not notice persons approaching.**

Always wear suitable clothing, protective gloves, and stout shoes.

Always ensure that you have a secure foothold whilst working.

Do not work on slippery surfaces.

### **TRANSPORT**

The tools lithium-ion batteries are subject to the Dangerous Goods Legislation requirements. The user can transport the batteries by road without further requirements. When being transported by third parties, special requirements on packaging and labelling must be observed. For preparation of the item being shipped, consult an expert for hazardous material

### **DISPOSAL**

The garden product, accessories and packaging should be sorted for environmental-friendly recycling. Do not dispose of garden products, battery chargers and batteries/rechargeable batteries into household waste!



Only for EC countries: According to the European law 2012/19/EU, electrical and electronic equipment that are no longer usable, and according to the European law 2006/66/EC, defective or used battery packs/batteries, must be collected separately and disposed of in an environmentally correct manner.

## SET UP & PREPARATION FOR OPERATION

Familiarise yourself with the grass shear. If you believe you are missing any components, please contact us:  
TEL: 01793 333212 or EMAIL: [customerservice@handydistribution.co.uk](mailto:customerservice@handydistribution.co.uk)  
(MON – FRI 8.00AM TO 5.30PM EXCL. BANK HOLIDAYS)

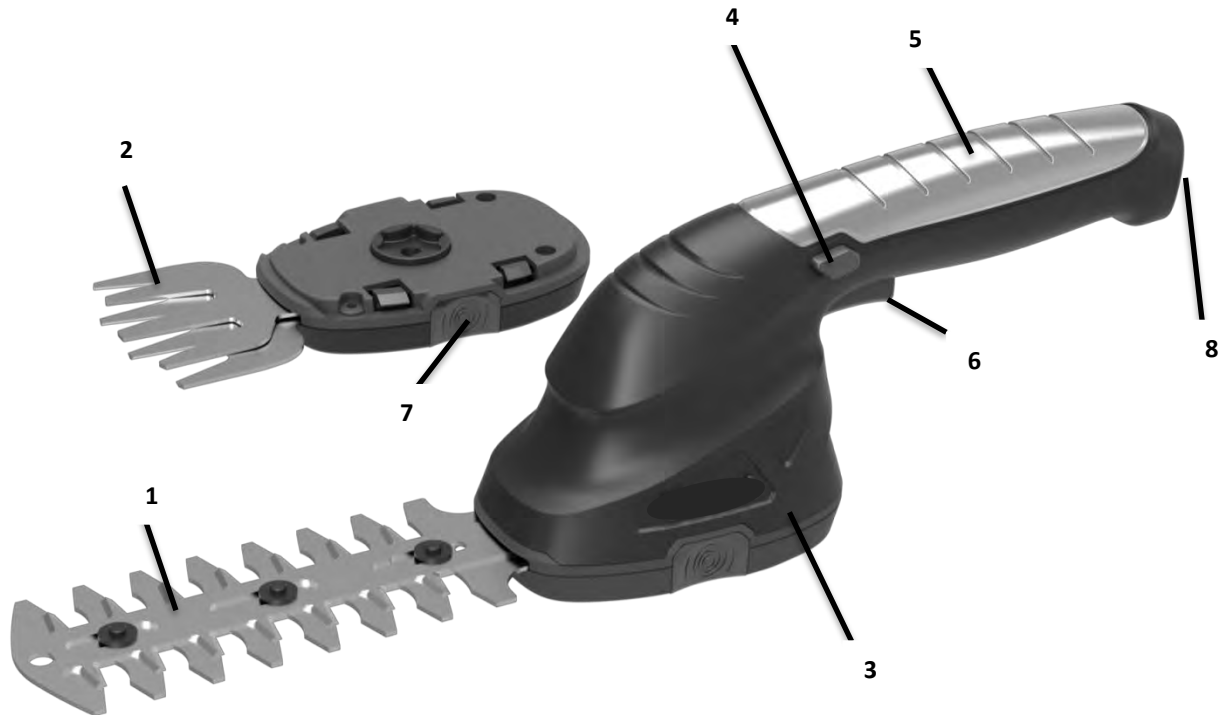

1	Hedge Shears Blade Assembly	2	Grass Shear Blade Assembly
3	Motor Housing	4	Safety Lock Button
5	Handgrip	6	ON/OFF Trigger
7	Blade Release Button	8	Charging Port

## ASSEMBLY

Remove the machine and contents from the carton. Be sure the carton is empty before discarding. **If you require any assistance with regards to the contents or operation of your machine, please call our Customer Service Team on 01793 333212 or email [customerservice@handydistribution.co.uk](mailto:customerservice@handydistribution.co.uk) (Monday to Friday 8.00am to 5.30pm excl. Bank Holidays)**

This Grass Shear does not require assembly.

## OPERATION



### WARNING

First clear away any stones, wires or other solid objects from where you want to cut.

### CHARGING

- The charging point (8) is located at the rear of the handle.
- Insert the charger into the charging point of the tool.
- Plug the BS 3-pin plug into your power source.
- Charging an empty battery will take up to 3 hours.

### TURNING ON & OFF

- The safety lock button (4) prevents the tool being switched on accidentally. To switch on the tool, you must first press the safety lock button with your thumb, then pull the ON/OFF trigger (6) upwards to start up the tool. The blades will now reciprocate
- Once the tool is up and running, you can release the safety lock button.
- To turn off the tool, release the ON/OFF trigger. The blades will momentarily continue to reciprocate, after the ON/OFF trigger has been released before coming to a complete stop.

### CHANGING BETWEEN BLADES

Press both blade release buttons, located on the side of the blade housing and lift the blade assembly away from the main motor housing (1 & 2).

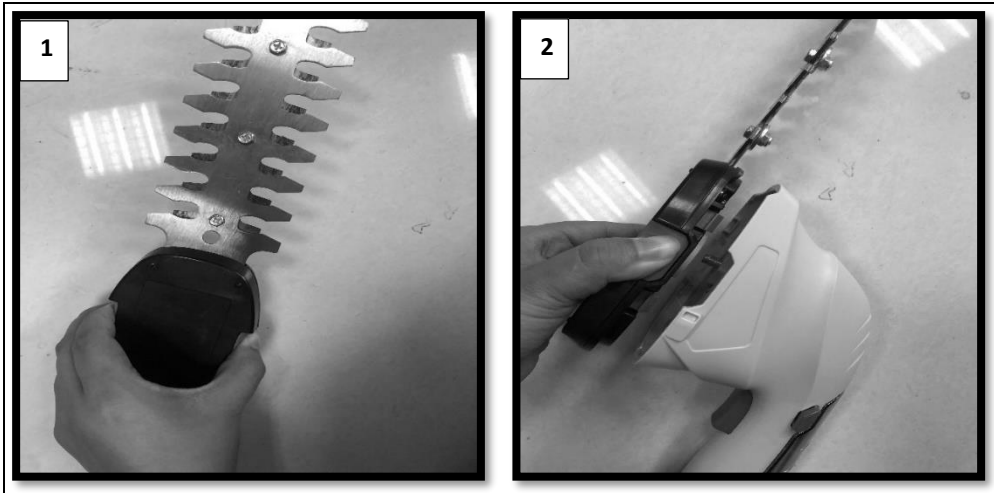

To seat the blade housing, press both blade release buttons and press against the main motor housing, until seated and then release both blade release buttons (3 & 4)

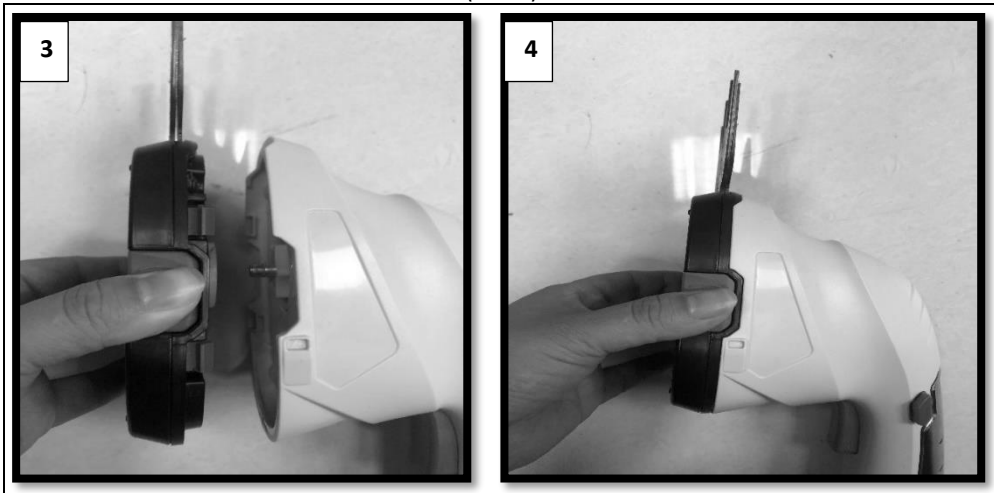

### **Cutting Grass.**

Simply put the tool at the chosen height and allow the tool to glide above the lawn to achieve the same cutting length of the grass.

Best performance can be achieved when the lawn is dry.

### **Trimming Hedges**

The tool can be used to trim small hedges and shrubs. Hold the tool slightly tilted in relation to the hedge you want to cut. First cut the sides from the bottom up, then cut the top.



**When not in use, always put on the protective blades cover on both blades.**

The run time for each blade are - Hedge Shear up to 45mins, Grass Shear up to 25mins. These figures can vary depending on the tool's usage etc.

When you notice a drop in cutting performance, recharge the tool immediately so that the battery does not become fully discharged.



**It is prohibited to remove or bridge any of the switching elements installed on the tool by the manufacturer as this would prevent the tool from switching off automatically and result in high risk of injury.**

## **MAINTENANCE & CLEANING**

To achieve good results, you should always keep the blades sharp. We recommend that you immediately level off any snags or ridges caused by stones or similar. The tool should be thoroughly cleaned both before and after use. A few drops of oil (e.g. sewing machine oil) will improve the cutting performance of the blades, but never apply any grease to the blades. To ensure constant exact cutting it is also important to remove grass remnants and dirt from between the upper and lower blades.



**Never clean the tool under running water – and particularly never with high pressure - because of the potential danger to persons and property. Keep your cordless grass cutter combination in a dry and frost-proof place and out of reach of children.**

**Note:** When storing the machine for longer than 6 weeks:

- Fully discharge the battery (by running the product) and then recharge the battery for 3-5 hours.
- Store in a dry and frost-free place.
- Recharge the battery every 1 or 2 months during the winter, because the battery will discharge slowly.

## **SERVICE HINTS**

Store the machine. Operating instructions and where necessary the accessories in the original packaging. In this way you will always have all the information and parts ready to hand.



**Please observe the following directions for the disposal of your accumulator/battery.**

**Batteries are not to be put into the rubbish. As a consumer you are legally obliged to return used batteries and accumulators. At the end of the duration of your tool, the batteries or accumulators must be taken from the apparatus, disposing of them separately. You have the possibility of delivering your old batteries and accumulators to the local collecting points of your municipality or to your dealer or to the distribution centers.**



## EC DECLARATION OF CONFORMITY

We Handy Distribution Ltd - SN3 5HY (Importer) declare that the product:

**Designation:** Lithium-ion Cordless Battery Hedge Trimmer & Grass Shear

**Model(s):** THGSS

**Product Number:** 1938195001

**Type/Serial No:** As per rating label on machine

**Battery Voltage:** 3.6Vd.c

**No Load Speed:** 1180rpm

**Amp Hours:** 1.5Ah

**Noise Emission Value:** LwA 80 dB(A)

**Vibration:** < 2.5 m/s<sup>2</sup> - Uncertainty K: 1,5m/s<sup>2</sup>

**Complies with the following directives:**

2006/42/EC – Machinery Directive

2014/30/EU - EMC Directive

**The conformity assessment procedure followed was in accordance with**

EN 60745-1:2009+A11:2010; EN 60745-2-15:2009+A1:2010; EN5636-2-94:2014; EN62233:2008  
EN 55014-1:2017; EN 55014-2: 2015; EN 61000-3-2: 2014; EN61000-3-3: 2013

**Notified Bodies:**

Intertek Testing Services Shanghai

**Address(es):**

Building No. 86, 118 Qinzhou Road (North), Shanghai 200233, China

**Authorised Signatory & Technical File Holder:**

**Date:**

30/01/2019

**Signature:**

A handwritten signature in black ink, appearing to read 'S Belcher', written over a horizontal line.

**Name:**

Mr. Simon Belcher

**Position:**

Chairman

**Company:**

Handy Distribution Ltd

**Address:**

Murdock Rd, Dorcan, Swindon, Wiltshire, SN3 5HY.

# PARTS DIAGRAM – THGSS (1938195001)

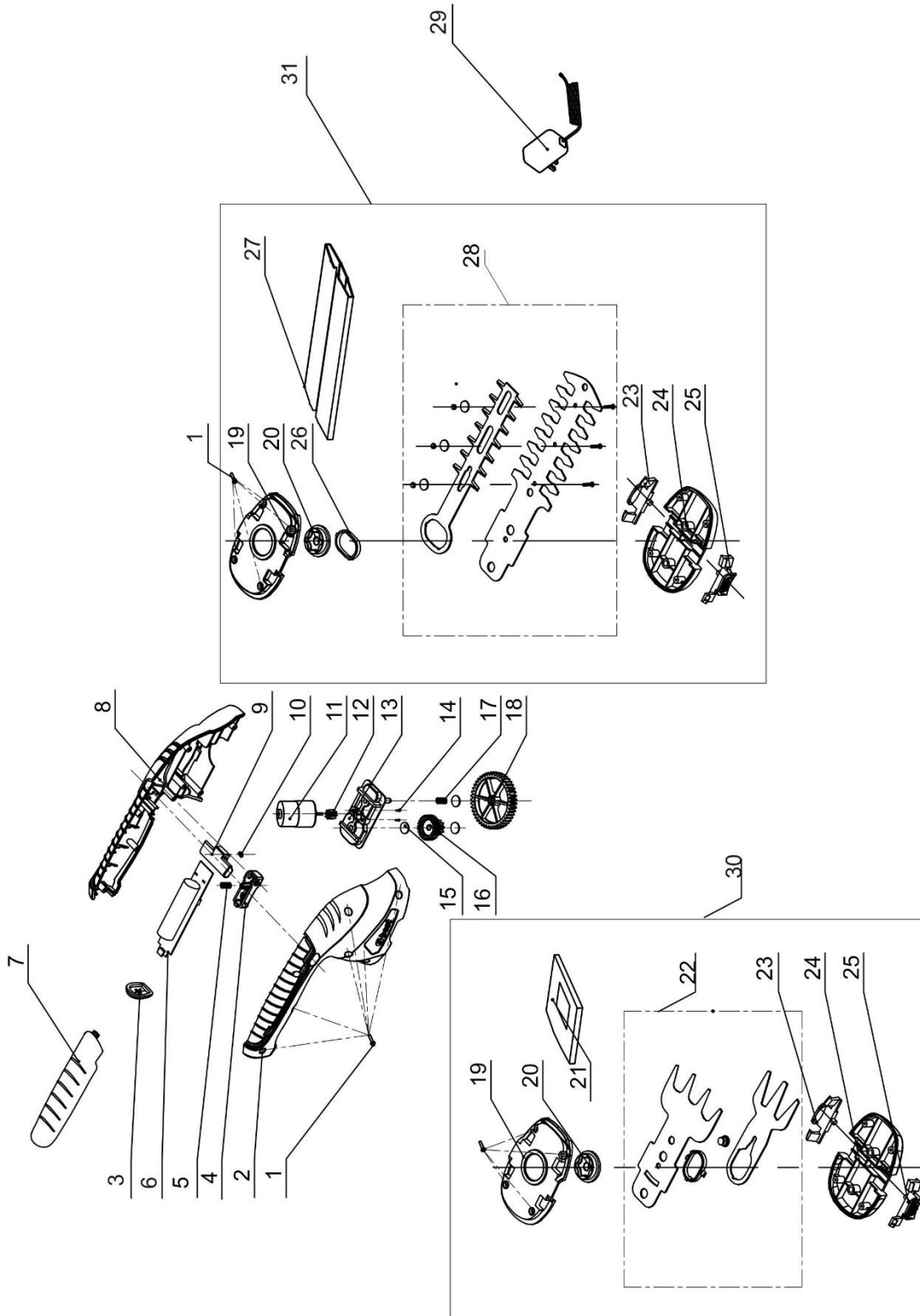

## PARTS LIST – THGSS (1938195001)

Item No	Handy Part No.	Handy Description	Qty
1	TH249-104030123	Self-Tapping Screw	14
2	TH249-301063110A	Right housing (Grey)	1
3	TH249-301063225	Handle Back Cover (Grey)	1
4	TH249-301063113A	Switch Button (Green)	1
5	TH249-103060051	Front Lift Spring	1
6	TH249-3030001	3.6v Lithium Battery Assembly	1
7	TH249-301063114A	Handle Cover	1
8	TH249-301063111A	Left Housing (Grey)	1
9	TH249-301063115A	Safety Button (Green)	1
10	TH249-103060335	Push Button Spring	1
11	TH249-102010628	DC Motor	1
12	TH249-103070138	Motor Gear	1
13	TH249-301063124	Motor Support Assembly	1
14	TH249-104030332	Disc Head Screw	2
15	TH249-104010273	Flat Washer	3
16	TH249-301063123	Duplicate Gear	1
17	WE145-103060235	Main Switch Knob Spring	1
18	TH249-301063116	Big Gear Wheel	1
19	TH249-301063117	Blade Housing Top (Grey)	2
20	TH249-301063118	Eccenter	2
21	TH249-301062315	Grass Shear Blade Cover	1
22	TH249-4990190	Grass Shear Blades	1
23	TH249-301063120	Blade Assembly Left Button (Green)	2
24	TH249-301063125	Blade Housing Bottom (Grey)	2
25	TH249-301063121	Blade Assembly Right Button (Green)	2
26	TH249-301063122	Hedge Shear Blade Wear Ring	1
27	TH249-301063126	Hedge Shear Blade Cover	1
28	TH249-103030146	Hedge Shear Blades	1
29	TH249-102050105	Charger (BS 3-Pin Plug)	1
30	TH249-GSBLADE	Grass Shear Blade Assembly (Grey/Green)	1
31	TH249-HSBLADE	Hedge Shear Blade Assembly (Grey/Green)	1

# GJ HANDY & CO LTD USER WARRANTY POLICY

## **Users Statement of Warranty**

Each new machine is warranted against defective material or assembly of material under normal usage. The warranty applies to the original purchaser and covers faulty parts and the labour involved in replacing and repairing those parts, which are of original manufacture.

## **Period of Warranty**

### **Webb (excludes Electric Handheld, Dynamic, Heritage, Legacy), Webb Pro, Sanli Engine**

- a) 2 years from the original date of sale to the first domestic user.
- b) 90 days from the original date of sale to the professional/commercial user.
- c) 90 days from the original date of sale when used for hire.
- d) A reduced warranty period of 90 days applies to those items which are subject to normal wear and tear (e.g. but not limited to wheels, tyres, cutter bars, cylinders, cutting blades, blade boss, belts, cables, nylon line & spool, collection bags, spark plugs).
- e) Engines are supplied with a separate warranty to the machine. The engine manufacturers warranty statement which will be supplied within the engine instruction manual. All enquiries and warranty repairs should be discussed with the engine manufacturer or approved warranty repair dealer.
- f) 90 days from the original date of purchase for Replacement Spare Parts (unless normal wear & tear component, which are covered for 30 days).
- g) All machines' must be serviced within the first 12 months from the original date of purchase to comply with the warranty, failure to do so will invalidate the 2nd year of the warranty.

### **Webb Electric Handheld, Webb Dynamic, Heritage & Legacy, The Handy, Mowerland, Q-Garden**

- a) 1 year from the original date of sale to the first domestic user.
- b) 90 days from the original date of sale to the professional/commercial user.
- c) 90 days from the original date of sale when used for hire.
- d) A reduced warranty period of 90 days applies to those items which are subject to normal wear and tear (e.g. but not limited to wheels, tyres, cutter bars, cylinders, cutting blades, blade boss, belts, cables, nylon line & spool, collection bags, spark plugs).
- e) Engines are supplied with a separate warranty to the machine. The engine manufacturers warranty statement which will be supplied within the engine instruction manual. All enquiries and warranty repairs should be discussed with the engine manufacturer or approved warranty repair dealer.
- f) 90 days from the original date of purchase for Replacement Spare Parts (unless normal wear & tear component, which are covered for 30 days).

All warranty repairs must be undertaken by an authorised service dealer. These dealers have been accredited by GJ Handy & Co Ltd and agree to only use genuine parts and follow our repair procedures.

## **Not covered by this warranty**

- a) The warranty policy does not cover any depreciation or damages caused by ordinary wear, rusting or corrosion, lack of correct maintenance or operation, misuse, abuse, lack of transportation or accident.
- b) The warranty policy does not cover any costs necessary for the standard periodic maintenance services instructed by the operator's manual, or service parts replacement which would include oil, filters, tyres, belts, brake linings, fuses, blades, seals and other service parts unless it can be proven that the item has evidence of faulty manufacture.
- c) The warranty policy will not cover failure or damage caused as a result of parts or accessories being modified without the written approval of GJ Handy & Co Ltd.
- d) The warranty policy will not cover the unit if non-genuine parts have been fitted and as a result damage has occurred to the unit.
- e) The warranty policy is non-transferable and is only applicable to the original purchaser.



**Disclaimer**

This warranty is only a remedy for defect of products. GJ Handy & Co Ltd will never warranty in terms of the merchantability or the fitness for a particular purpose.

No person is authorised to make any warranties, representations or promises, expressed or implied, on behalf of GJ Handy & Co Ltd, or to modify the terms conditions or limitation of this warranty policy in any way.

Neither GJ Handy & Co Ltd nor any company affiliated with GJ Handy & Co Ltd shall be liable in any event or manner whatsoever for incidental or consequential damages or injuries, including, but not limited to, loss of crops, loss of profit, out of pocket expenses or profits, rental of substitute equipment or other commercial losses.

**General**

Most warrantable failures show up within the first few weeks of use. These failures are usually straightforward and warranty assessment is relatively easy.

Failures relating to cutter decks and belts need careful investigation, as the cause may not always be straightforward. Look for damage to blades and pulleys especially when the cutter belt or blade boss have snapped or cracked as this could be due to impact damage.

Customers should always refer to the operator/instruction manual when any disputed problem arises, you will find most areas covered within the manual.





**For spares or support of your handy product,  
please contact us:**

**Tel: 01793 333212**

**Email: [customerservice@handydistribution.co.uk](mailto:customerservice@handydistribution.co.uk)  
(Mon – Fri 8.00am to 5.30pm excl. Bank Holidays)**

**To see our range of garden machinery & equipment visit:**

**[www.thehandy.co.uk](http://www.thehandy.co.uk)**

**Making gardening easier & affordable since 1938**

Distributed by Handy Distribution, Murdock Road, Dorcan, Swindon, SN3 5HY